

1.

7.2.

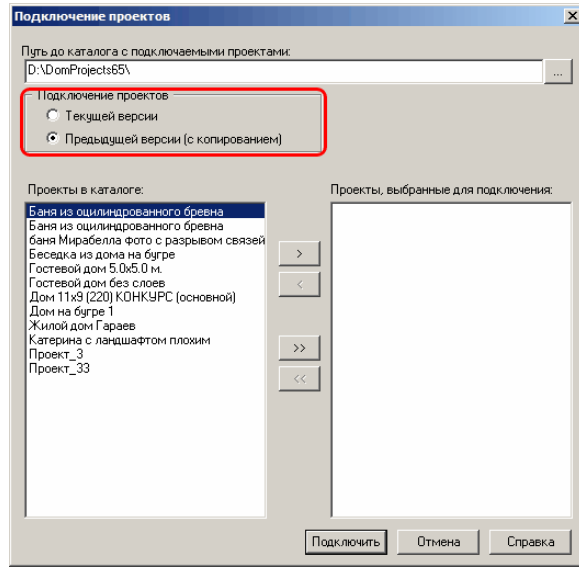

2.

Excel, *.txt.

3-

1.

2.

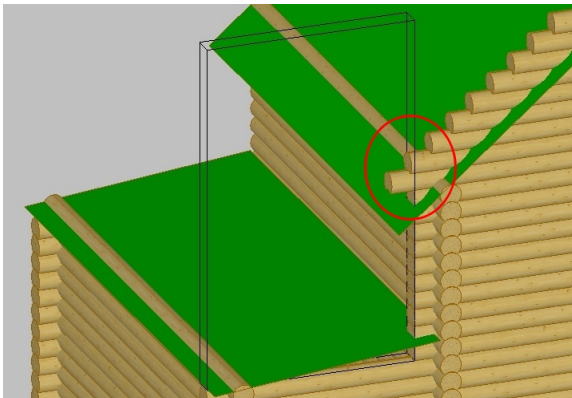

6.5

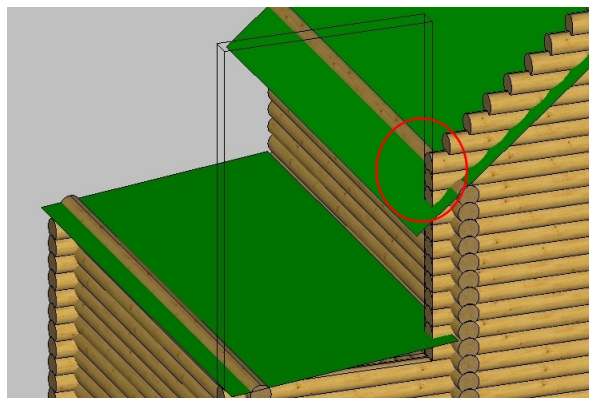

7.2

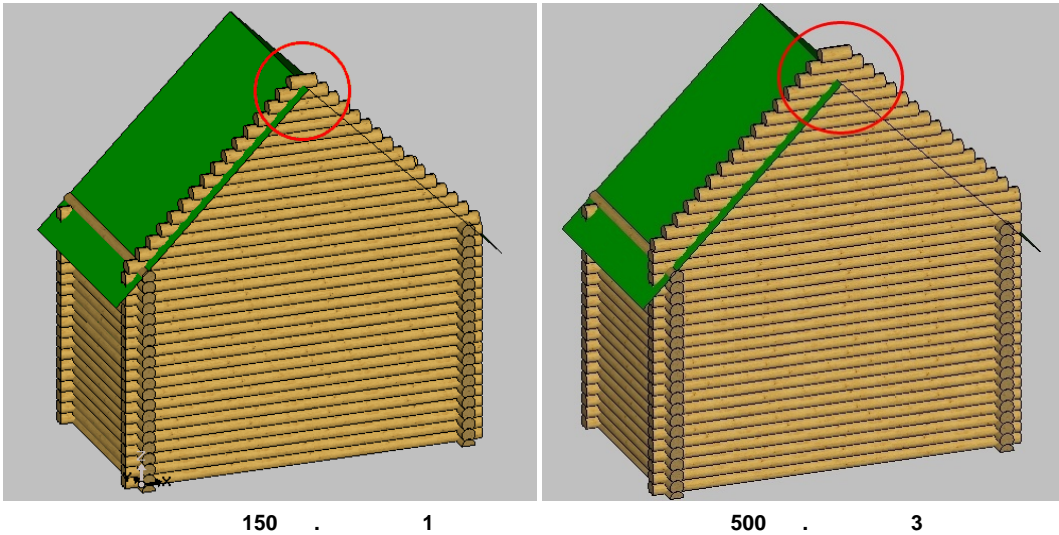

3. (). /

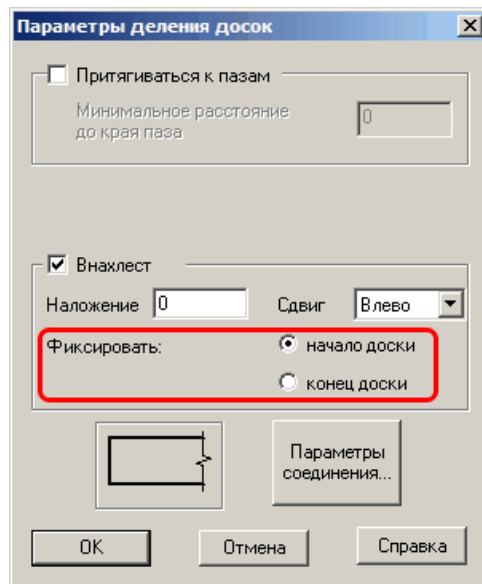

4.

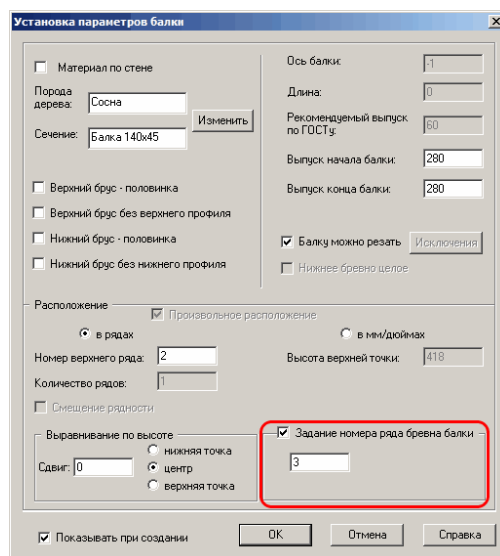

5.

1.

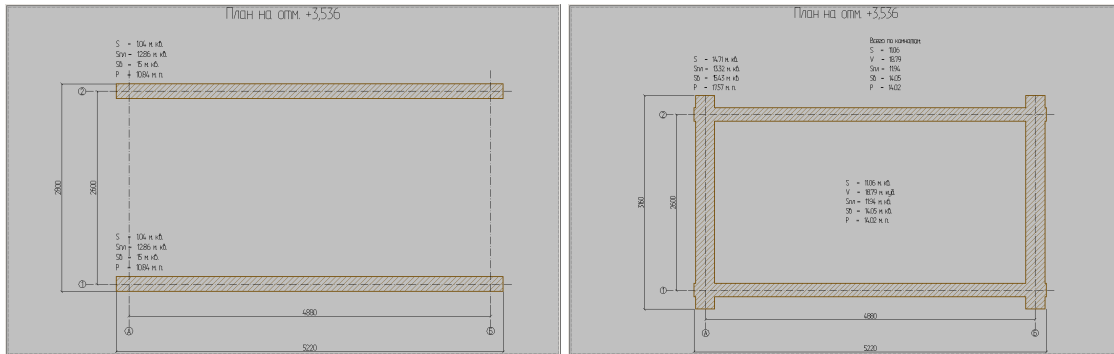

2.

(.).

3.

(. . .)

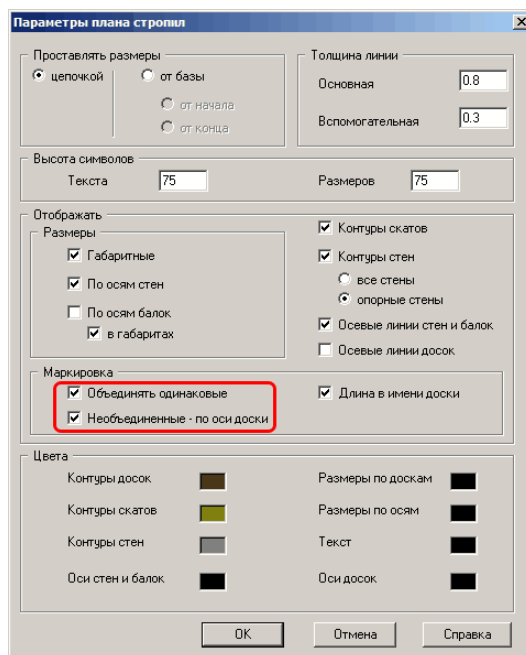

4.

_____ ,
_____ .

1.

_____ : _____ .

2.

_____ ; _____ 10 _____ .
_____ , _____ 1 _____ .

3.

_____ .

4.

_____ , _____ / _____ .

5.

_____ .

6.

_____ , _____ .

7.

_____ , _____ .

8.

_____ (_____) .

9.

_____ / _____ / _____ .

10.

_____ , _____ , _____ .

11.

_____ , _____ .

12.

_____ / _____ .